



CLIENT  
Groundworks  
The Vench

PROJECT  
Playroom

PROJECT NO.  
0110.19

DRAWN BY  
Jacob Corn

DRAWINGS  
Nested Workbenches -  
Large Workbench

# The Vench Playroom - Nested Workbenches - Large Workbench - Beauty Shots

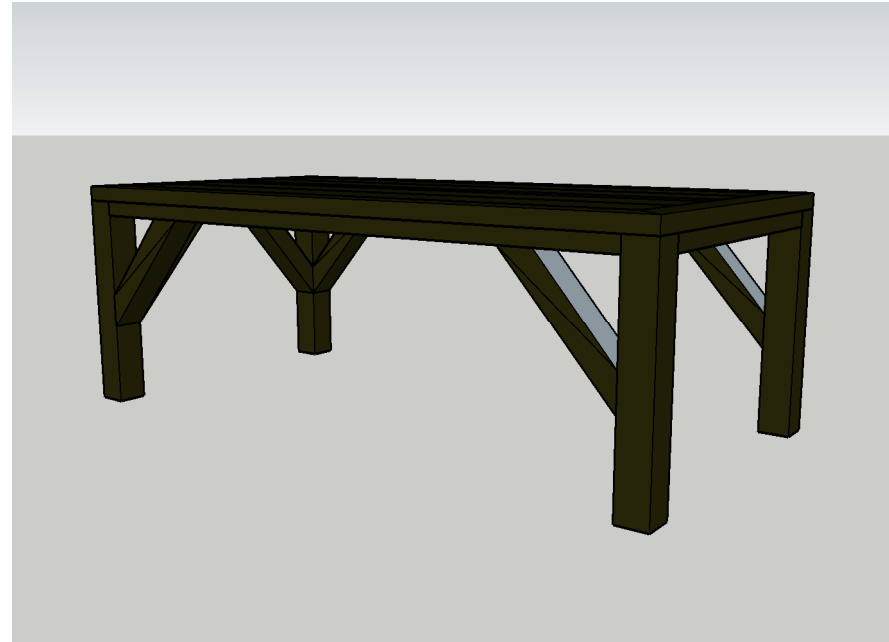
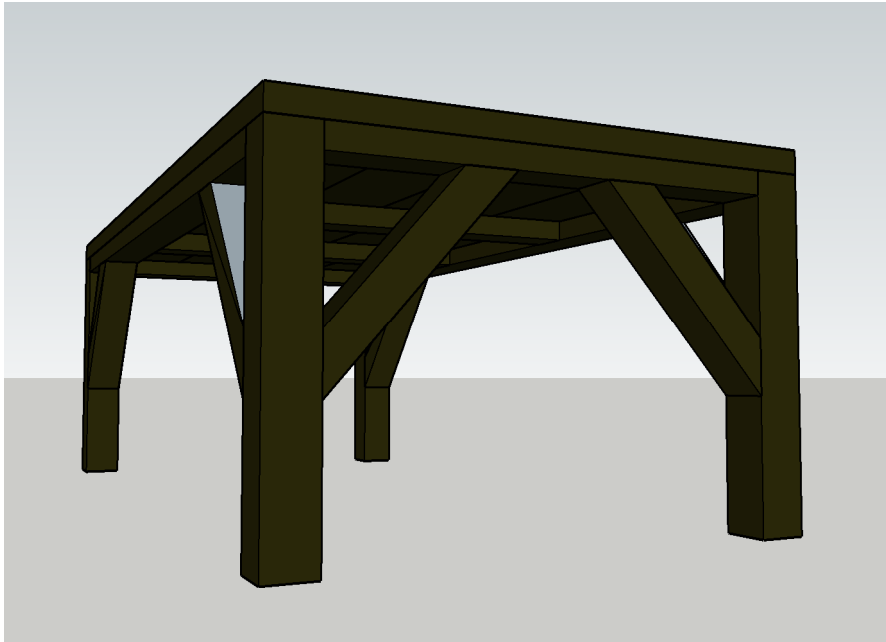
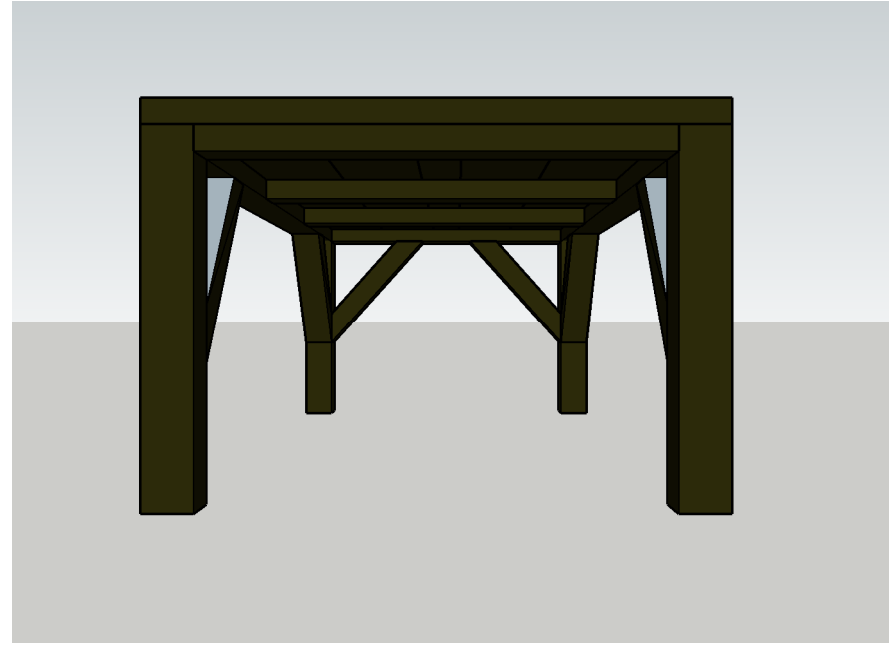
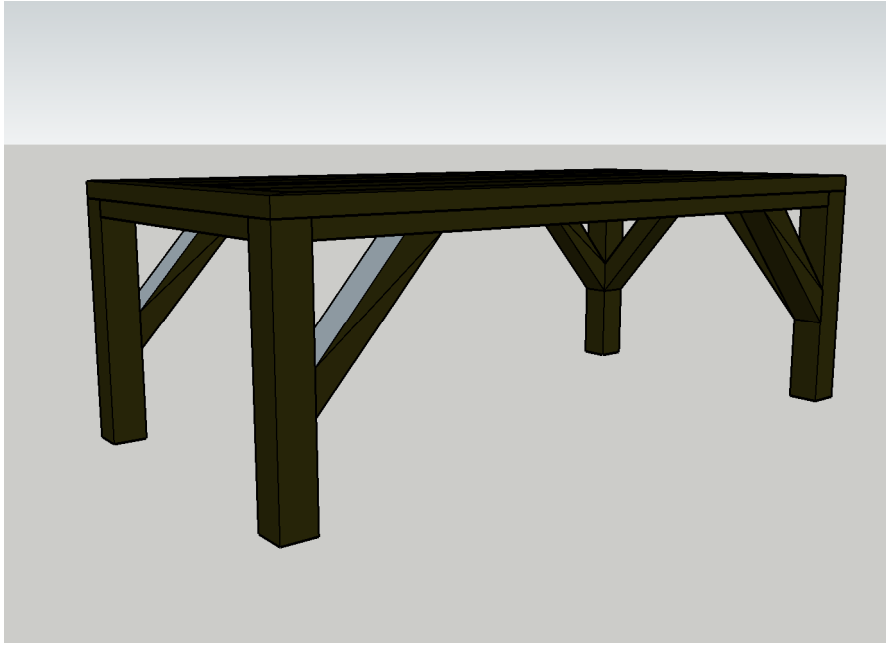

CLIENT  
Groundworks  
The Vench, Lockleaze

Scale  
1:25 @A4

PROJECT NO.  
0110.19  
PROJECT  
Playroom

DRAWN BY  
Jacob Corn  
DESCRIPTION  
Workbench - Large

# The Vench Playroom - Nested Workbenches - Large Workbench - Technical Elevations

Front Elevation

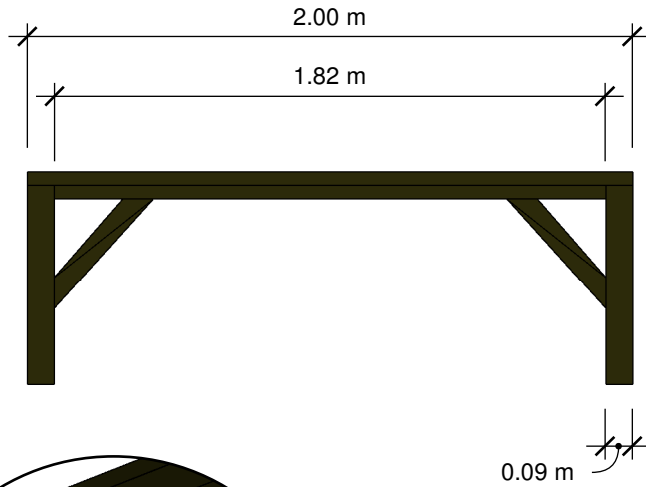

Top Elevation

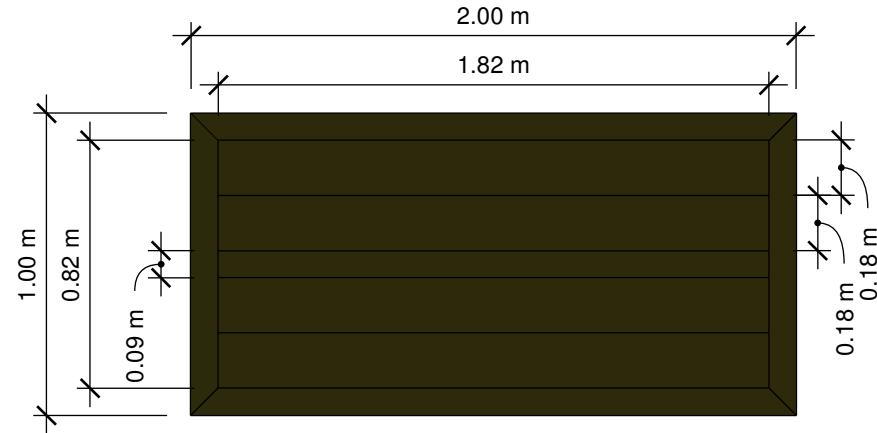

0.09 m

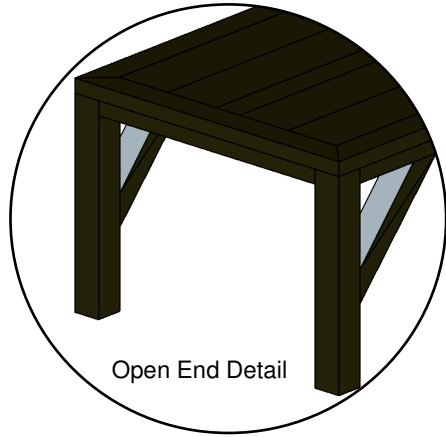

Open End Detail

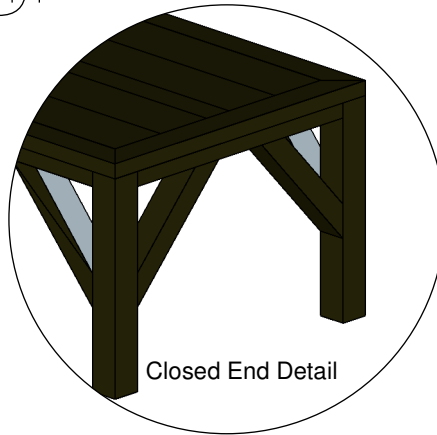

Closed End Detail

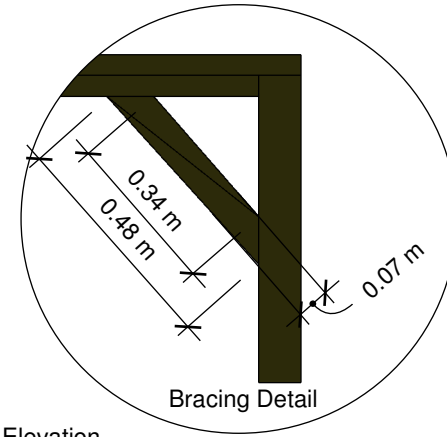

Bracing Detail

Right Elevation

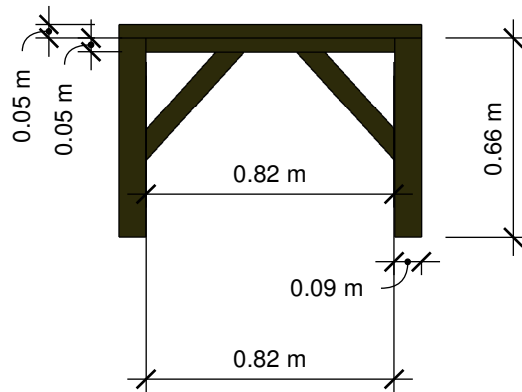

Bottom Elevation

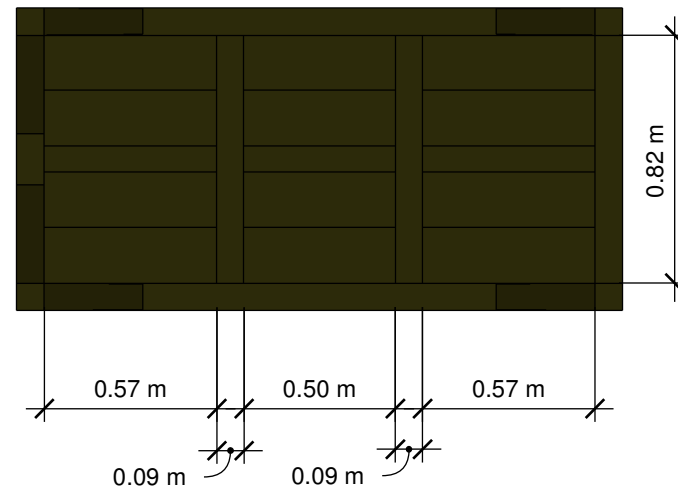

CLIENT  
Groundworks  
The Vench, Lockleaze

Scale  
1:25 @A4

PROJECT NO.  
0110.19  
PROJECT  
Playroom

DRAWN BY  
Jacob Corn  
DESCRIPTION  
Workbench - Large